

SNAPPER™

by

Briggs & Stratton®
POWER PRODUCTS

G1000

Illustrated Parts List



Snapper™ is a licensed trademark of Briggs & Stratton Power Products.

Snapper™ se usa abajo licencia a Briggs & Stratton Power Products.

Questions? Help is just a moment away!

Preguntas? La ayuda es justa un momento lejos!

Call: Generator Helpline - 1-800-317-7833 M-F 8-5 CT

Llamada: Generador Helpline - 1-800-317-7833 M-F 8-5 CT

BRIGGS & STRATTON POWER PRODUCTS GROUP, LLC
JEFFERSON, WISCONSIN, U.S.A.

Model No. 01666-0 (1000 Watt AC Generator) Manual No. 190091A Revision 0 (05/18/2005)

EXPLODED VIEW AND PARTS LIST – MAIN UNIT

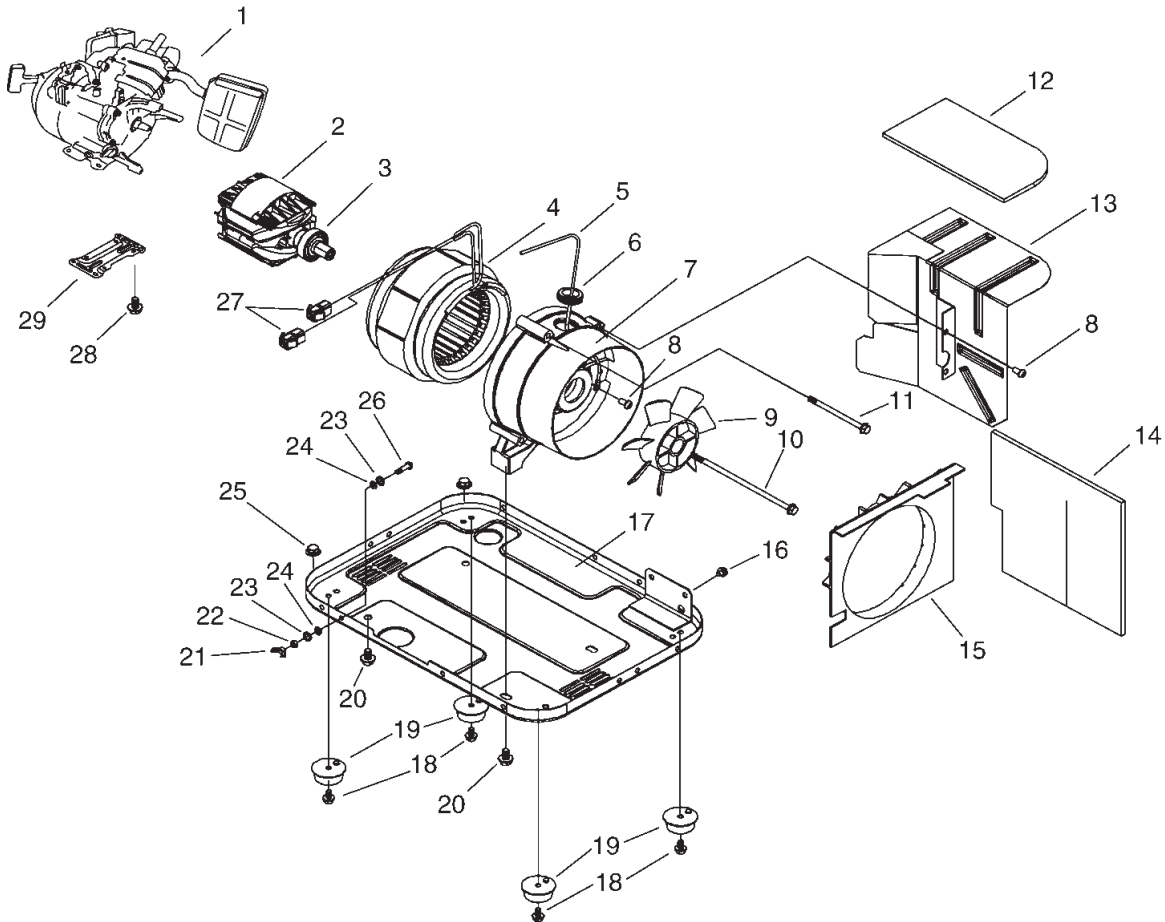

Item	Part #	Description	Item	Part #	Description
1	§	ENG, 2.4HP (050032-0113-E1)	16	187392GS	PHMS, M6-1.0, W/L/FW
2	187378GS	ROTOR	17	187383GS	BASE, GEN
3	187411GS	BRG	18	187390GS	BOLT, FLNG, M6-1.0 X 10
4	187379GS	STATOR	19	187385GS	MNT, VIBR
5	187430GS	LEAD, GREEN	20	187427GS	HHCS, FLNG, M8-1.25 X 12
6	187409GS	BUSHING, LEAD WIRE, G790B	21	187424GS	NUT, WING, M5 X 0.8
7	187381GS	RBC, 1K	22	187423GS	NUT, M5 X 0.8
8	187399GS	SCREW, SELF TAP, M6-12	23	187419GS	WSHR, LOCK
9	187382GS	FAN, COOLING	24	187420GS	WSHR, FLAT
10	187388GS	BOLT, RTR	25	187401GS	NUT, M8-1.25, FLANGE
11	187389GS	BOLT, STATOR	26	187415GS	PHMS, M5-0.8 X 20
12	187405GS	INSLTN, HEAT SEALED, #1	27	187413GS	CNNCTR
13	187384GS	MFFLR, SEALED	28	187434GS	HHCS, FLNG
14	187407GS	INSLTN, HEAT SEALED, #2	29	187431GS	STND, ENG
15	187403GS	DUCT, AIR			

§ - Contact Engine Manufacturer

1000 Watt Portable Generator

WIRING DIAGRAM

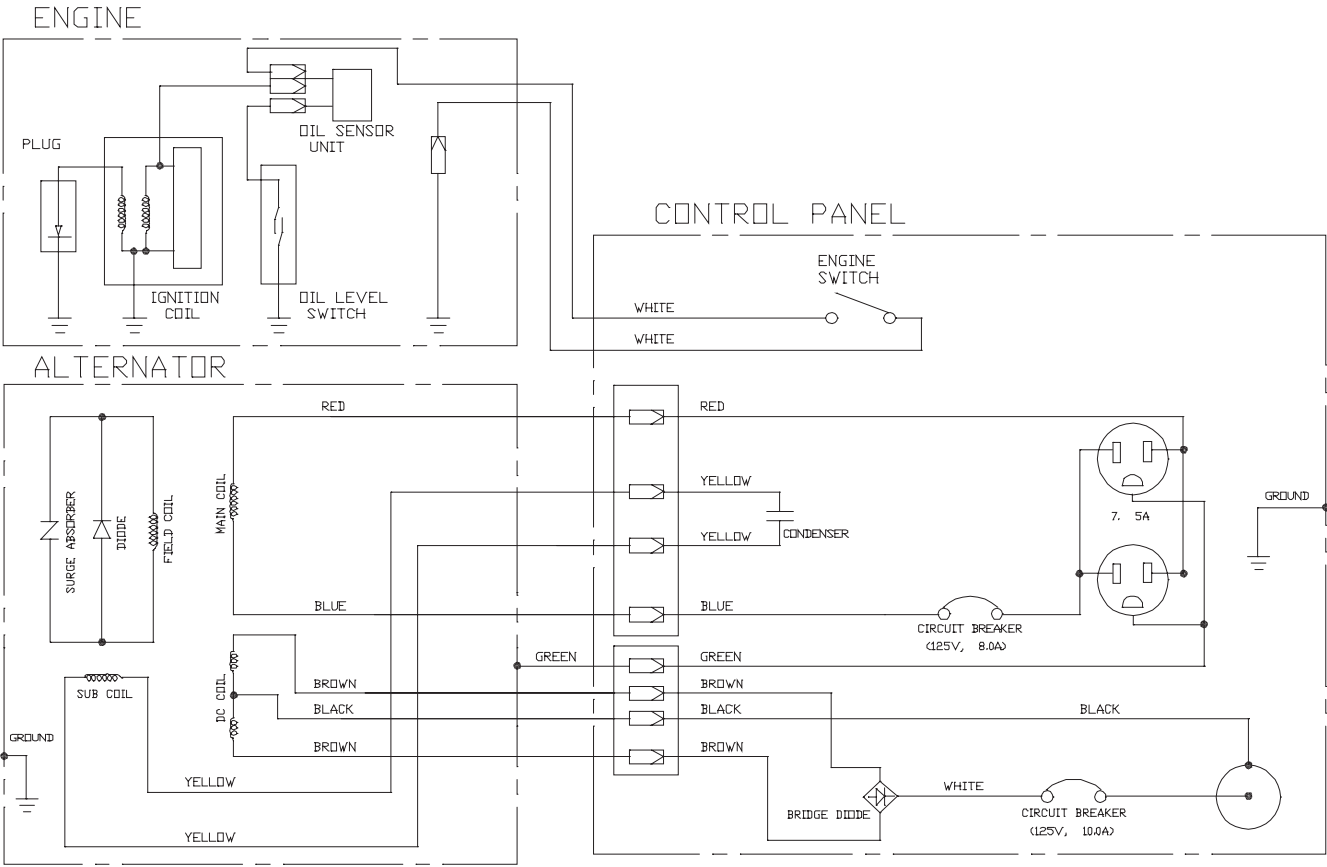



Wiring Diagram & Schematic

SAFETY WARNINGS

Safety Alert Symbols

The safety alert symbol () is used to identify hazards that can result in personal injury. A signal word (**DANGER, WARNING or CAUTION**) is used with the alert symbol to indicate the potential severity of injury. In addition, a hazard symbol may be used to represent the type of hazard.





 **DANGER:** Indicates a hazard which, if not avoided **will result in death or serious injury.**

 **WARNING:** Indicated a hazard which, if not avoided **could result in death or serious injury.**

 **CAUTION:** Indicates a hazard which, if not avoided **might result in death or serious injury.**

CAUTION: When used without the alert symbol, indicates a situation that could result in damage to equipment or components.

HAZARD SYMBOLS AND MEANINGS

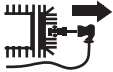
 **Explosion**
 **Fire**
 **Shock**
 **Entanglement**
 **Disconnect Spark Plug**

WD-SCH-01

 **DANGER**



Generators produce powerful voltages. Failure to isolate generator from power utility can result in death or injury to electric utility workers due to backfeed of electrical energy.

- When testing generators used for backup power, notify utility company.

WD-SCH-05

CAUTION: The measuring equipment used in troubleshooting this equipment should be of industrial quality and should have the sensitivity to measure electronic values to the third decimal. Its accuracy should conform with acceptable industry tolerances. Ensure that all specified tools and/or equipment are available before attempting to troubleshoot.

WD-SCH-03

 **DANGER**



Physical contact with energized electrical components will result in dangerous and possibly fatal electrical shock.

- Do not touch bare wires or receptacles.

WD-SCH-04

 **CAUTION**





These wiring diagrams and schematics are intended for use by trained and qualified electrical service technicians who are working in a properly equipped service environment. Familiarity with the proper method of using tools, measuring equipment and service procedures is essential to performing successful troubleshooting and repair of this equipment.

- Only qualified electrical technicians should attempt to service this equipment.

WD-SCH-02

 **WARNING**

Accidental starting of the unit may cause entanglement or electrocution.

- Where applicable, disconnect the negative (-) battery terminal.
- Disconnect the spark plug wire.
- Remove the control panel fuse when available.

WD-SCH-07